

PRODUCT SPECIFICATIONS

Elkay Lustertone™ Stainless Steel 33" x 22" x 4", Equal Double Bowl Top Mount ADA Sink. Sink is manufactured from 18 gauge 304 Stainless Steel with a Lustertone finish, Rear Center drain placement, and Bottom only pads.

Installation Type:	Top Mount
Material:	304 Stainless Steel
Finish:	Lustertone
Gauge:	18
Sound Deadening:	Bottom only pads
Number of Bowls:	2
Sink Dimensions:	33" x 22" x 4"
Bowl 1 Dimensions:	13-1/2" x 16" x 3-5/8"
Bowl 2 Dimensions:	13-1/2" x 16" x 3-5/8"
Drain Size:	3-1/2" (89mm)
Drain Location:	Rear Center
Minimum Cabinet Size:	36"
Mounting Hardware:	Part # 64090014 included for countertops up to 3/4" (19mm) thick
Cutout Template #:	1000001189

Template is available for download at [elkay.com](#)

Cutout Dimensions for Top Mount Installation:

32-3/8" x 21-3/8" (822mm x 543mm) with 1-1/2" (38mm) corner radius



AMERICAN PRIDE. A LIFETIME TRADITION.
Like your family, the Elkay family has values and traditions that endure. For almost a century, Elkay has been a family-owned and operated company, providing thousands of jobs that support our families and communities.



Product Compliance: ADA & ICC A117.1
ASME A112.19.3/CSA B45.4
BUY AMERICAN ACT



Sinks are listed by IAPMO® as meeting the applicable requirements of the Uniform Plumbing Code®, International Plumbing Code®, and National Plumbing Code of Canada.



Complies with ADA & ICC A117.1 accessibility requirements when installed according to the requirements outlined in these standards.

[Clean and Care Manual \(PDF\)](#)
[Installation Instructions \(PDF\)](#)
[Limited Lifetime Warranty \(PDF\)](#)

Similar models are available with: Quick-Clip Mounting System, additional ADA depths

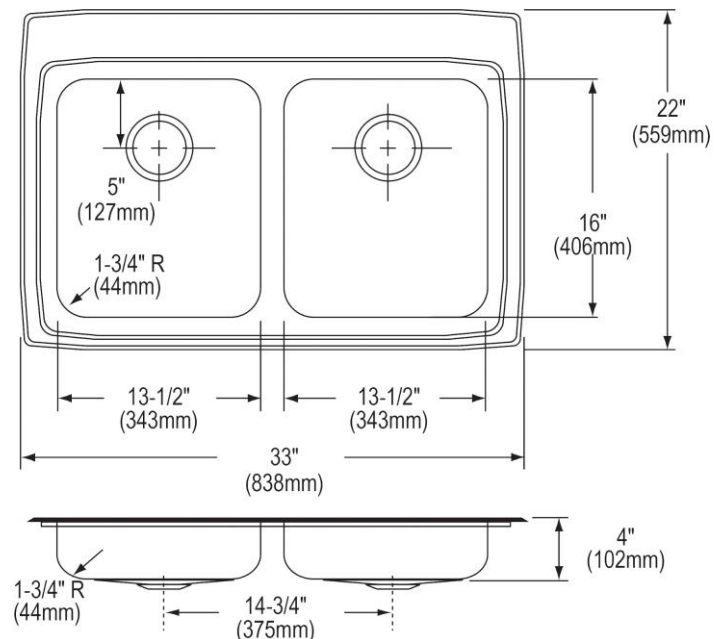

PART: _____ QTY: _____

PROJECT: _____

CONTACT: _____

DATE: _____

NOTES: _____

APPROVAL: _____

In keeping with our policy of continuing product improvement, Elkay reserves the right to change product specifications without notice. Please visit [elkay.com](#) for the most current version of Elkay product specification sheets. This specification describes an Elkay product with design, quality, and functional benefits to the user. When making a comparison of other producers' offerings, be certain these features are not overlooked.

Hole Drilling Configurations:

1-1/2" (38mm) Diameter Faucet Holes on 4" (102mm) Centers

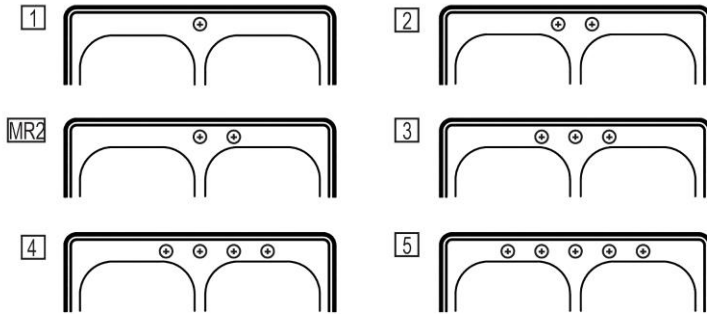

Installation Profile:

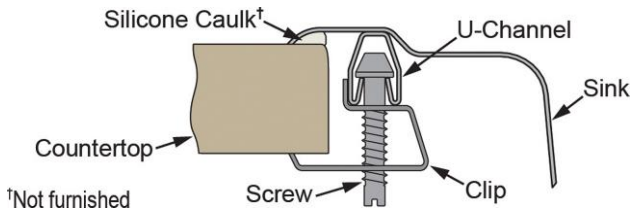

OPTIONAL ACCESSORIES

Bottom Grid:	LKWOBG1316SS
Cutting Board:	CB1613, CB1713, CBS1316
Drain:	LK99, LKAD35
Faucet:	LKGT1041, LKGT2041
Hardware:	LK364, LK463
Rinsing Basket:	LKWRB1316SS, LKWERBSS
Sinkmate:	LKSMHSL
Soap Dispenser:	LKGT1054

In keeping with our policy of continuing product improvement, Elkay reserves the right to change product specifications without notice. Please visit elkay.com for the most current version of Elkay product specification sheets. This specification describes an Elkay product with design, quality, and functional benefits to the user. When making a comparison of other producers' offerings, be certain these features are not overlooked.