

### Features

- 36-inch minimum base cabinet width.
- KOHLER cast iron.
- Acid-resistant enamel finish.
- Under-mount.
- Single bowl.
- No faucet holes.
- Offset drain basin slopes toward drain to minimize water from pooling.
- Self-Trimming® apron overlaps cabinet face for easy installation and beautiful results.
- 35-11/16" (907 mm) x 21-9/16" (548 mm)

### Recommended Accessories

K-9000 P-Trap

### Optional Accessories

K-6639 Sink Rack

K-8801 Sink Strainer



### Codes/Standards

















ASME A112.19.1/CSA B45.2

### KOHLER® Enameled Cast Iron Kitchen Sink - Lifetime Limited Warranty

See website for detailed warranty information.

### Available Color/Finishes

*Color tiles intended for reference only.*

Color	Code	Description
	0	White
	FF	Sea Salt™
	96	Biscuit
	47	Almond
	FD	Cane Sugar™
	NY	Dune
	95	Ice™ Grey
	G9	Sandbar
	33	Mexican Sand™
	K4	Cashmere
	FT	Basalt
	58	Thunder™ Grey
	20	Suede
	KA	Black 'n Tan
	FP	Caviar
	7	Black Black™

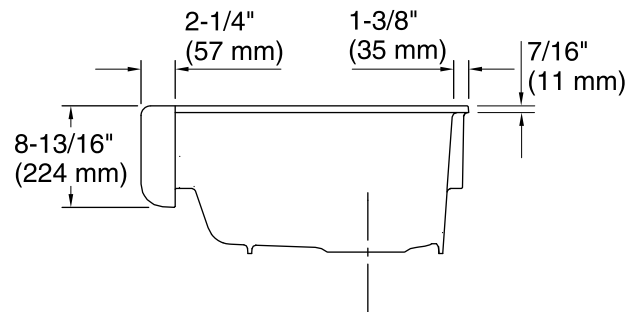
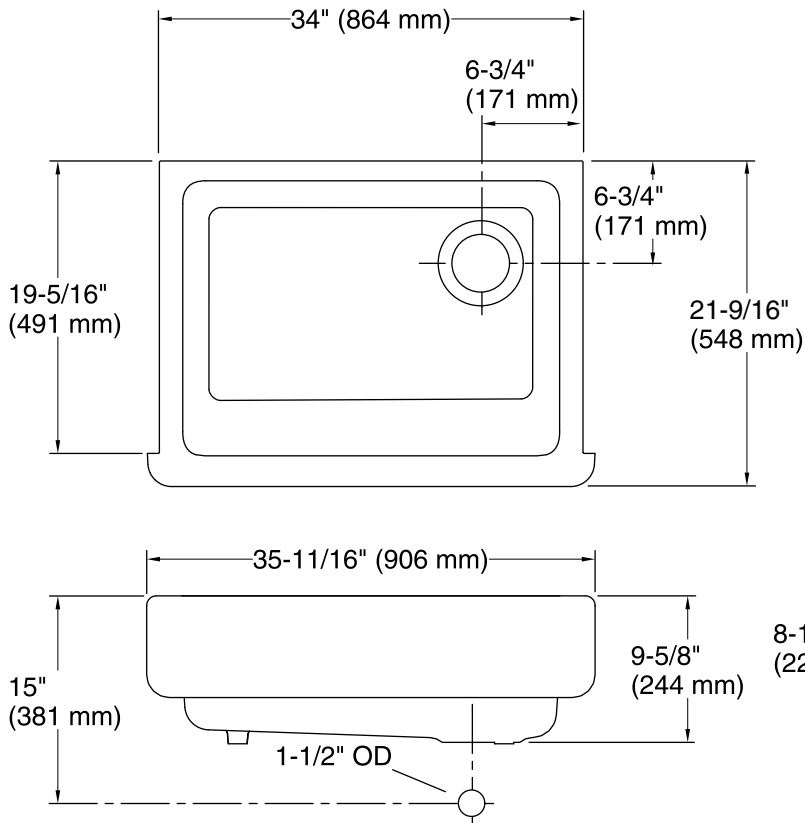

### Technical Information

All product dimensions are nominal.

Bowl configuration:	Single
Installation:	Under-mount
Min. base cabinet width:	36" (914 mm)
Bowl area (Only)	Length: 30-3/4" (781 mm) Width: 18-1/16" (459 mm) Bowl depth: 9" (229 mm)
Drain hole:	3-5/8" (92 mm)
Template:	1156910-7, required, included 1157001, required, included

### Notes

Install this product according to the installation instructions.

**IMPORTANT!** The distance from the top edge of the cabinet to the top of the cabinet door must be at least 9" (229 mm) to install this sink.