

Features

- Low profile single, double or peninsula shower base with natural stone effect.
- Ultra low 1" threshold front curb for easy access and finishes flush with most finished floors.
- Heavy duty Sheet Molding Compound material.
- Installation for new and existing construction.
- 1" high aluminum tiling flange included.
- Bases can be trimmed in the field to fit your space.
- Select from single, double or peninsula threshold.
- Slip resistant; lightly textured slate floor for a safe environment yet maintains an easy to clean surface.
- Color-matched SMC drain cover for end drain models. Drain not included.
- Optional threshold can be added to form a conventional base. Design is similar to other Trimslate bases and will accommodate the current add-on threshold.
- 10 Year Limited Residential / 3 Year Commercial Warranty



Specified Models

| | Model No. | Length A | Width B | Ctr C | Ctr D | Height |
|--------------------------|------------|----------|---------|--------|--------|--------|
| <input type="checkbox"/> | SMFZSP6032 | 59.1" | 31.5" | 29.55" | 15.75" | 1" |
| <input type="checkbox"/> | SMFZSP6036 | 59.1" | 35.5" | 29.55" | 17.75" | 1" |

To Be Specified: Color

| | |
|--------------------------|-------------------------|
| <input type="checkbox"/> | 33 Caramel |
| <input type="checkbox"/> | 59 Tundra Grey |
| <input type="checkbox"/> | 60 Dolomite |
| <input type="checkbox"/> | 61 Argenti Black |



Caramel **33**

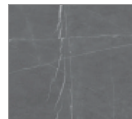

Tundra Grey **59**



Dolomite **60**

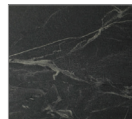

Argenti Black **61**

CUSTOMIZABLE BASE

Note: Bases can be built to accommodate unique sizes. Notches can also be cut from the bases to allow for columns in a corner.

Base can be built to custom sizes within certain limitations. Can be trimmed up to 4" in width away from side opposite drain or up to 2" from depth on end drain models. Base is designed to be used as a single, double or triple threshold in stock sizes.

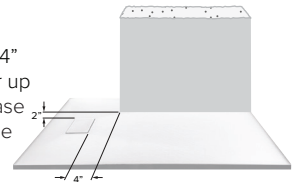

Codes/Standards

The specified model meets or exceeds the following:

ASTM E662

CSA B45.5/IAPMO Z124

Notes: Install this product according to the installation instructions.

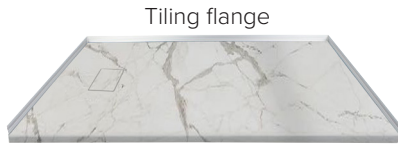
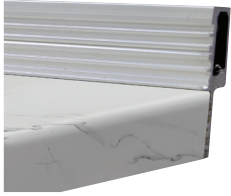

Tiling flange



Modern Slip Resistance with a stone look texture. Easy to clean as well as slip resistant.



SMFZSP6032

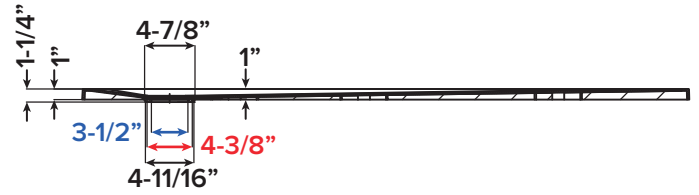
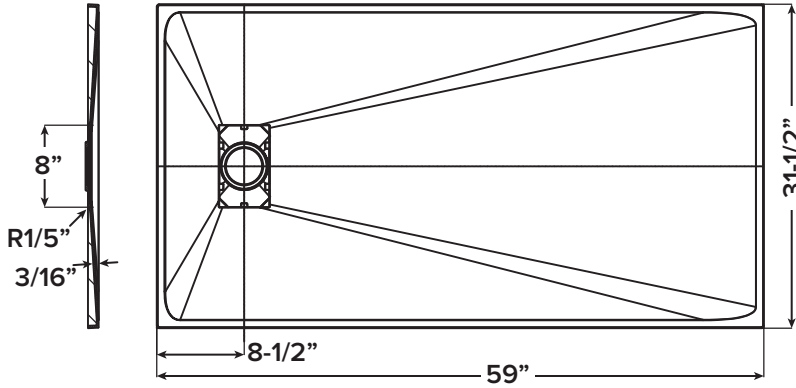

SMFZSP6032

