









MARIS

FRAGRANITE 33" DOUBLE BOWL SINK MAG6201515

TECHNICAL FEATURES

Overall Sink Size (OD)	33" x 22"
Equal Bowl Size (ID)	15 ³ / ₁₆ " x 16 ¹ / ₁₆ "
Bowl Depth (ID)	9 ¹ / ₂ "
Corner Radius	16mm
Minimum Cabinet Size	36"
Installation Type	Dual Mount
Weight	43 lbs.
Warranty	Limited Lifetime

AVAILABLE FINISHES

 Champagne MAG6201515-CHA 114.0686.994	 Onyx MAG6201515-ONY 114.0686.997
 Stone Grey MAG6201515-SHG 114.0687.000	 Oyster MAG6201515-OYS 114.0686.998
 Polar White MAG6201515-PWT 114.0686.999	 Matte Black MAG6201515-MBK 114.0686.995
 Mocha MAG6201515-MOC 114.0686.996	 Slate Grey MAG6201515-SLG 114.0713.094

OPTIONAL ACCESSORIES

Bottom Grid MA-15-36S 112.0687.993	Roller Mat MA2-31RM 112.0080.355	Colander PX-70S 112.0066.060
Cutting Board MA2-40S 112.0688.102	Drain Cover RNDCVR 112.0532.169	Colorline Cover RNDCVR-XXX (xxx represents color)
Colorline Strainer 900-XXX (xxx represents color)	Colorline Flange WD-900-XXX (xxx represents color)	

Product Image



Dimensional Drawing

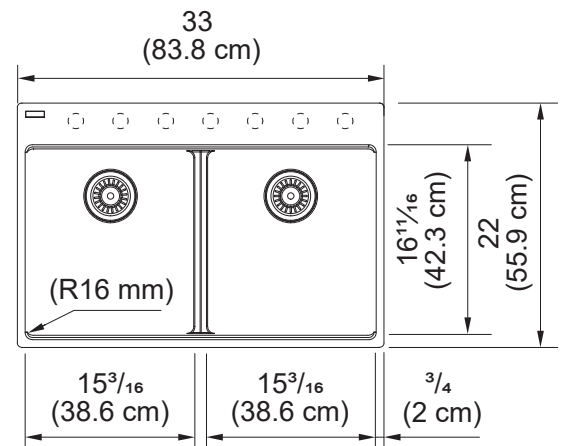

7 pre-scored holes for faucet and accessories

