

### Features

- Vitreous china.
- Drop-in.
- Rectangular basin.
- With overflow.
- 8-inch centers.
- Coordinates with other products in the Archer collection.
- 22-5/8" (575 mm) x 19-7/16" (494 mm) x 7-7/8" (200 mm)

### Recommended Accessories

K-8998 P-Trap



ADA

### Codes/Standards











ASME A112.19.2/CSA B45.1  
ADA  
ICC/ANSI A117.1

### KOHLER® One-Year Limited Warranty

See website for detailed warranty information.

### Available Color/Finishes

*Color tiles intended for reference only.*

Color	Code	Description
	0	White
	96	Biscuit
	47	Almond
	NY	Dune
	95	Ice™ Grey
	G9	Sandbar
	33	Mexican Sand™
	K4	Cashmere
	58	Thunder™ Grey
	7	Black Black™

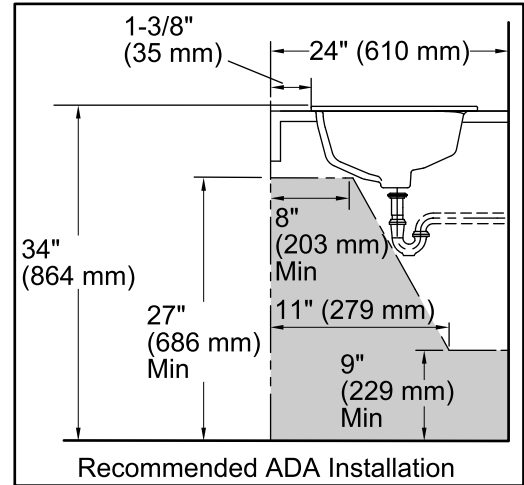
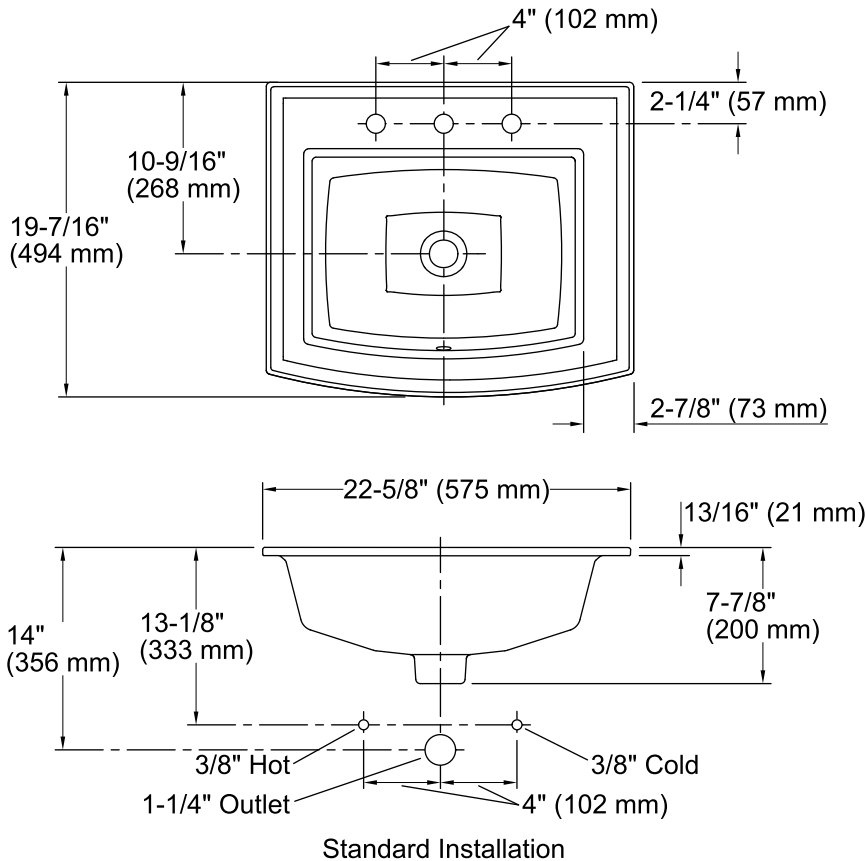

### Technical Information

All product dimensions are nominal.

Bowl configuration:	Single
Installation:	Drop-In
Bowl area (Only)	Length: 16-7/8" (429 mm) Width: 12-9/16" (319 mm) Water depth: 4" (102 mm)
Number of deck holes:	3
Faucet hole(s):	1-3/8" (35 mm)
Drain hole:	1-3/4" (44 mm)
Template:	1051936-7, required, included

### Notes

Install this product according to the installation instructions.

**NOTICE:** Countertop manufacturer or cutter must use the cut-out template provided with the product, or a current one provided by Kohler Co. (call 1-800-4KOHLER). Kohler Co. is not responsible for cutout errors when the incorrect cut-out template is used.

ADA compliant when installed to the specific requirements of these regulations.