

Features

- Vitreous china.
- Drop-in.
- Rectangular basin.
- With overflow.
- 4-inch centers.
- Coordinates with other products in the Tresham collection.
- 21-13/16" (554 mm) x 16-9/16" (421 mm) x 8-1/16" (205 mm)

Recommended Accessories

K-8998 P-Trap



ADA

Codes/Standards











ASME A112.19.2/CSA B45.1
ADA
ICC/ANSI A117.1

KOHLER® One-Year Limited Warranty

See website for detailed warranty information.

Available Color/Finishes

Color tiles intended for reference only.

| Color | Code | Description |
|--|------|---------------|
|  | 0 | White |
|  | 96 | Biscuit |
|  | 47 | Almond |
|  | NY | Dune |
|  | 95 | Ice™ Grey |
|  | G9 | Sandbar |
|  | 33 | Mexican Sand™ |
|  | K4 | Cashmere |
|  | 58 | Thunder™ Grey |
|  | 7 | Black Black™ |

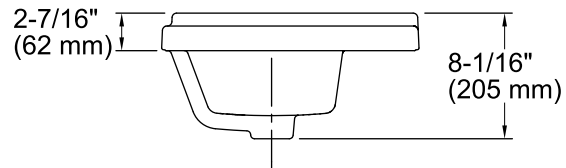
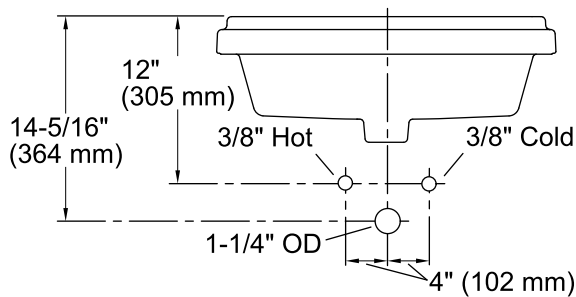
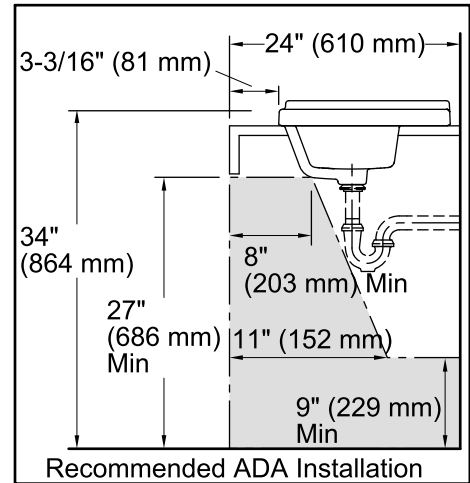
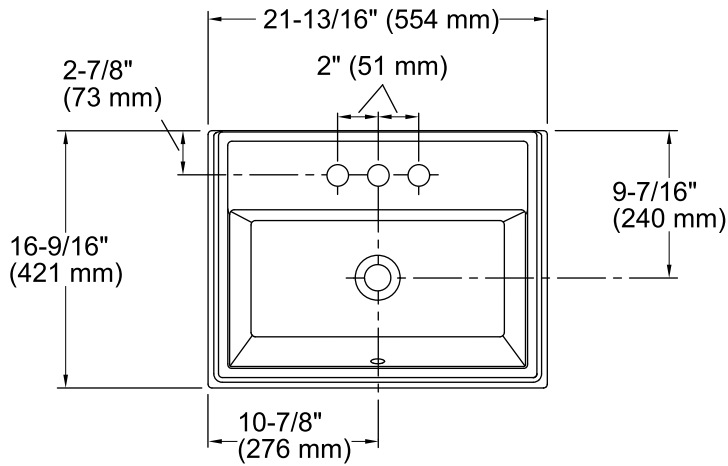

Technical Information

All product dimensions are nominal.

| | |
|-----------------------|---|
| Bowl configuration: | Single |
| Installation: | Drop-In |
| Bowl area (Only) | Length: 19-13/16" (503 mm) Width: 10-3/16" (259 mm) Water depth: 6-1/16" (154 mm) |
| Number of deck holes: | 3 |
| Faucet hole(s): | 1-1/4" (32 mm) |
| Drain hole: | 1-3/4" (44 mm) |
| Template: | 1162721-7, required, included |

Notes

Install this product according to the installation instructions.

NOTICE: Countertop manufacturer or cutter must use the cut-out template provided with the product, or a current one provided by Kohler Co. (call 1-800-4KOHLER). Kohler Co. is not responsible for cutout errors when the incorrect cut-out template is used.

ADA compliant when installed to the specific requirements of these regulations.